

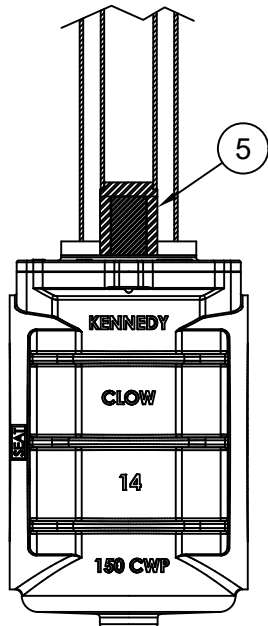

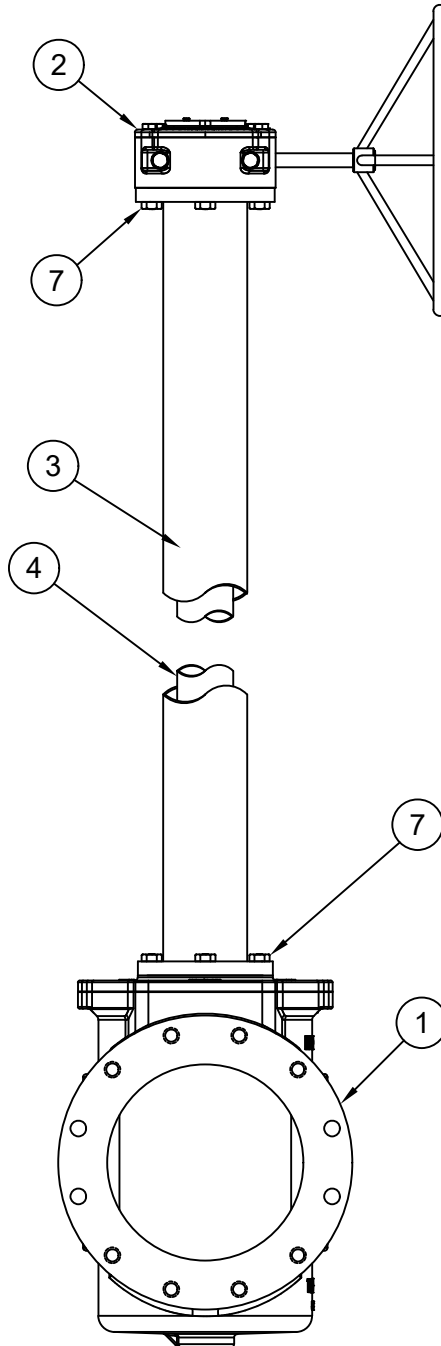

BILL OF MATERIAL			
No.	PART	STANDARD MATERIAL	OPTIONAL MATERIAL
1	Plug Valve	See Plug Valve MoC	-
2	Actuator	-	-
3	Mounting Extension	Carbon Steel	-
4	Shaft Extension	Carbon Steel	Stainless Steel, T304 or T316
5	Shaft Coupling	Carbon Steel	Stainless Steel, T304 or T316
6	Shaft Adapter	Carbon Steel	Stainless Steel, T304 or T316
7	Mounting Hardware	Stainless Steel, T304	Stainless Steel, T316

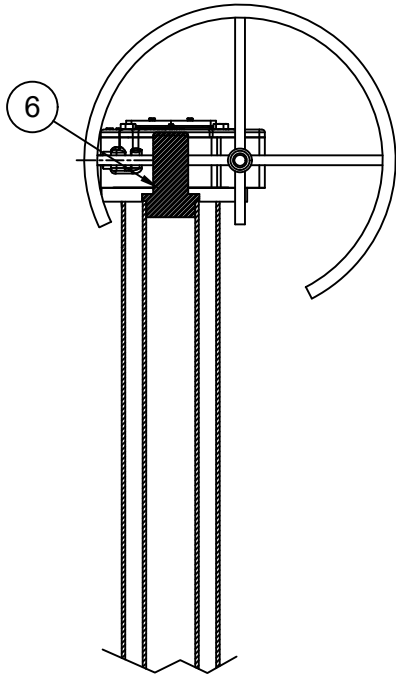

<b>DESCRIPTION:</b> Eccentric Plug Valve Extended Bonnet Materials of Construction	<b>DATE:</b> 04/10/2026	<b>DRAWING:</b> EP-MC0005-A	  
			

McWane Plant & Industrial  
 1201 Vanderbilt Road  
 Birmingham, AL 35234

Products and images depicted are for general illustrative purposes only and do not represent the complete scope of supply, configuration, or country of origin. Final product details are governed solely by McWane Plant & Industrial's standard Terms and Conditions of Sale.